

ENCLOSURE CORNER 16 x 16

This structural profile is made of clear anodized extruded aluminum. Two slots are provided to insert 1.5 mm thick aluminum sheet stock. Specially shaped channels are available at each end of the extrusion. These channels are designed to be used with M5 self-tapping screws or tapped with an M5 thread. This profile is used to construct enclosures for mechanical or electrical components.

Enclosure Profiles 16 x 16

1 meter length
HL4712M3010-1000

2 meters length
HL4712M3010-2000

3 meters length
HL4712M3010-3000

Hardware

Consists of 10 pieces each.
Corner clamp, M3 Square nut
& M3 x 10 screw
HL6100M129011

**For OEM and quality pricing,
contact our sales department.**

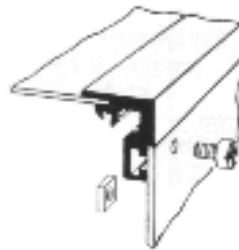
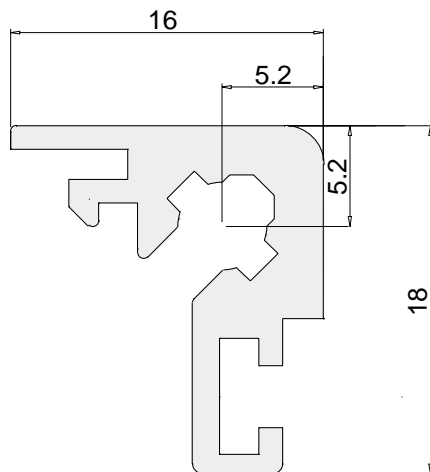

ENCLOSURE CORNER 16 x 18

This structural profile is made of clear anodized extruded aluminum. A slot is provided to inset 1.5 mm thick aluminum sheet stock. A T-nut slot is provided to allow a 1.5 mm thick aluminum sheet to be screwed to this profile. The T-slot is designed to accept a standard M3 nut or the M3 nut strip described in the accessory section. Specially shaped channels are available at each end of the extrusion to be used with M5 self-tapping screws or tapped with an M5 thread. This profile is used to construct enclosures for mechanical or electrical components.

In order to improve our products, we reserve the right to make engineering changes.

Enclosure Profiles 16 x 18

1 meter length
HL4712M3020-1000

2 meters length
HL4712M3020-2000

3 meters length
HL4712M3020-3000

Hardware

M3 T-slot nut
HL6100M1200

M3 x 4 screw
HL6100M49030-04

**For OEM and quantity pricing,
contact our sales department.**



Enclosure Profiles

These structural profiles are made of clear anodized aluminum. Slots on the inside surface of the profile are dimensioned to accommodate printed circuit boards in accordance to Euro-Card standards (100x160).

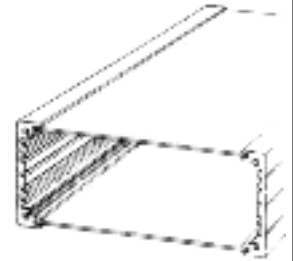
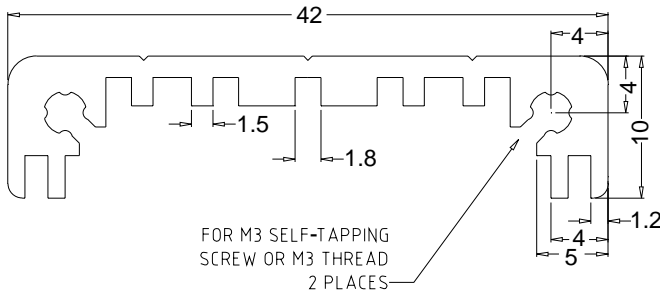

Enclosure Profiles 10x42

1 meter length
HL4712M2010-1000

2 meters length
HL4712M2010-2000

3 meters length
HL4712M2010-3000

For OEM and quality pricing, contact our sales department.

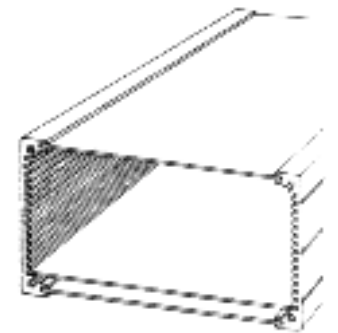
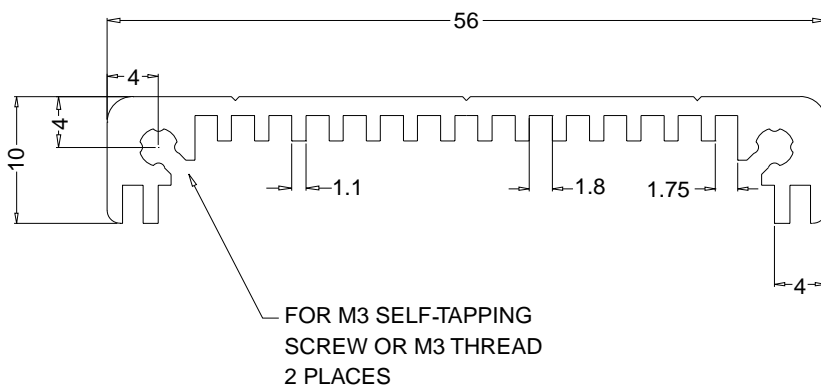

Enclosure Profiles 10x56

1 meter length
HL4712M2020-1000

2 meters length
HL4712M2020-2000

3 meters length
HL4712M2020-3000

For OEM and quality pricing, contact our sales department.

In order to improve our products, we reserve the right to make engineering changes.

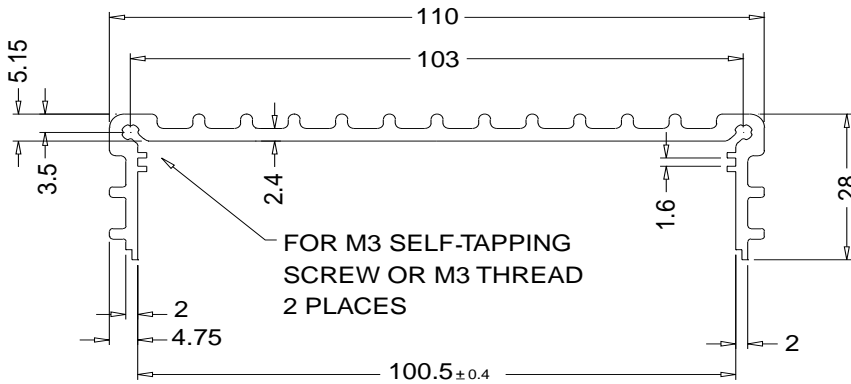

Enclosure Profiles 28x80

1 meter length
HL4712M0020-1000

2 meters length
HL4712M0020-2000

3 meters length
HL4712M0020-3000

These enclosure profiles are made of clear anodized aluminum. Slots on the inside surface of the profile are dimensioned to accommodate printed circuit boards in accordance to Euro-Card standards (100x160). These profiles can be combined to provide 55, 80 or 105 mm high enclosures.

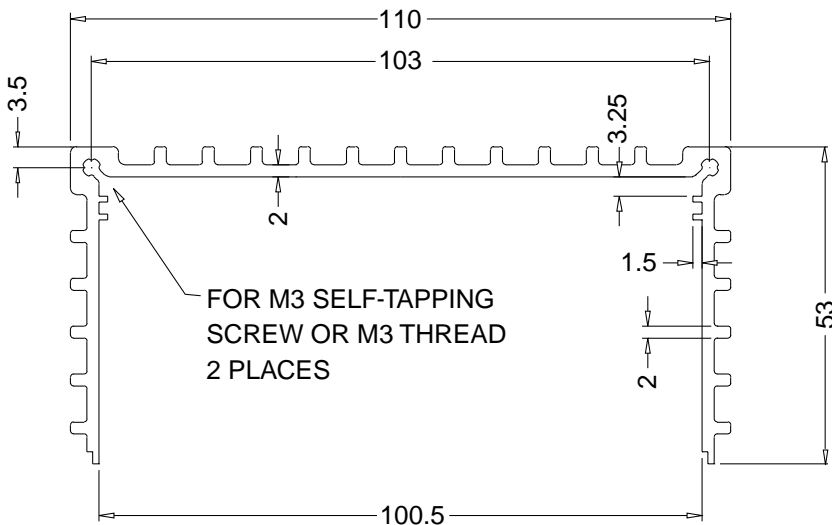

Enclosure Profiles 53x80

1 meter length
HL4712M0030-1000

2 meters length
HL4712M0030-2000

3 meters length
HL4712M0030-3000

**For OEM and quality pricing,
contact our sales department.**